

850nm Collimated Laser Diode Module | Single Mode LD| 50mw Output Power| Collimation Beam

840nm~850nm IR LD| Small Compact Package| Built-in PD| Built-in TEC Cooling Optional

WSLM-850-050m-K

Wavespectrum Laser, Inc.

www.wavespectrum-laser.com

850nm Collimated Laser Diode		50mw		Wavespectrum Laser, Inc	
PARAMETER	SYMBOL	VALUE	UNIT		
Reverse Voltage	V_r	3.5	V		
Operating Temperature	T_{op}	-10 ~ +50	°C		
Storage Temperature	T_{stg}	-40 ~ +85	°C		
Lead soldering temperature (10 sec.)	T_{is}	260	°C		
Features: <ul style="list-style-type: none"> ● 850nm ● Collimated Laser Beam ● Small Compact Package ● Excellent Beam Quality ● Built-in PD ● Built-in TEC Cooling Optional 					
Specifications		WSLM-850-050m-K			
		Min	Type	Max	
Center Wavelength@25°C		830nm	845nm	850nm	
Output Power (CW Mode)		50mw			
Spatial Mode		Single Mode			
Lens Type		Aspheric Lens (with AR Coating)			
Beam Shape		Elliptical			
Beam Diameter @ Aperture		----	5mm _L x 1.5mm _{//}	----	
Beam Divergence (Full Angle)		----	----	1mrad	
Recommend Operating Temperature		25 °C			
Monitor Current		----	0.3mA	1.0mA	
Threshold Current (Typ.)		----	15mA	25mA	
Operating Current (Typ.)		----	80mA	95mA	
Operating Voltage		----	2.0V	2.5V	
Housing Material		Aluminum			
Housing Dimensions		Customized			



Drawing

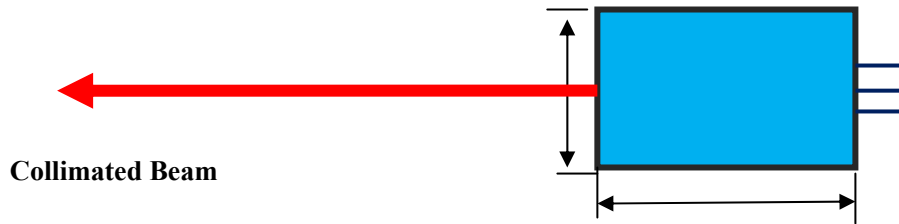

PIN Bottom View:

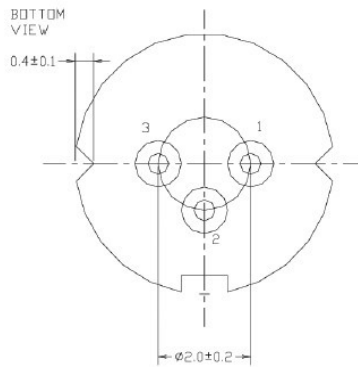

1	LD(-)
2	LD(+)&PD(-)
3	PD(+)

Electrically shorten LD module and store in non-extreme conditions.
 Suggest using the constant current power supply.

