

980nm Collimated Laser Diode Module | Single Mode LD| 50mw Output Power| Collimation Beam

980nm IR LD| Small Compact Package| Built-in PD| Built-in TEC Cooling Optional

WSLM-980-050m-K

Wavespectrum Laser, Inc.

www.wavespectrum-laser.com

980nm Collimated Laser Diode 50mw		Wavespectrum Laser, Inc	
PARAMETER	SYMBOL	VALUE	UNIT
Reverse Voltage	V_r	2.0	V
Operating Temperature	T_{op}	-10 ~ +40	°C
Storage Temperature	T_{stg}	-10 ~ +85	°C
Lead soldering temperature (10 sec.)	T_{is}	260	°C
Features: <ul style="list-style-type: none"> ● 980nm ● Collimated Laser Beam ● Small Compact Package ● Excellent Beam Quality ● Built-in PD ● Built-in TEC Cooling Optional 			
Specifications		WSLM-980-050m-K	
		Min	Type
Center Wavelength@25°C		970nm	980nm
Output Power (CW Mode)		50mw	
Spatial Mode		Single Mode	
Lens Type		Aspheric Lens (with AR Coating)	
Beam Shape		Elliptical	
Beam Diameter @ Aperture		----	5mm _L x 1.5mm _{//}
Beam Divergence (Full Angle)		----	1mrad
Recommend Operating Temperature		25 °C	
Monitor Current		----	0.3mA
Threshold Current (Typ.)		----	15mA
Operating Current (Typ.)		----	80mA
Operating Voltage		----	1.8V
Housing Material		Aluminum	
Housing Dimensions		Customized	



Drawing

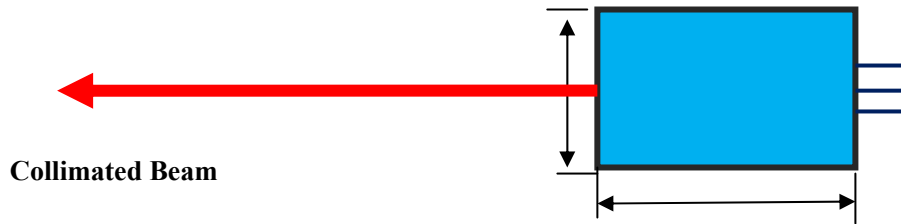

PIN Bottom View:

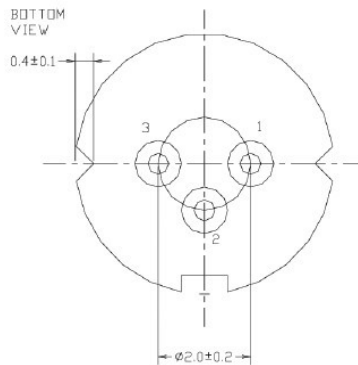

1	LD(-)
2	LD(+)&PD(-)
3	PD(+)

Electrically shorten LD module and store in non-extreme conditions.
 Suggest using the constant current power supply.

