

Receptacle Package InGaAs PIN Photodetectors

Wavespectrum Laser Inc.

Features: <ul style="list-style-type: none"> High Responsivity Low dark current Low terminal capacitance Receptacle package 	
Applications: <ul style="list-style-type: none"> Test Equipments Analog Optical Receiver 	

Absolute Maximum Ratings

PARAMETER	SYMBOL	VALUE	UNIT
Operating Temperature	T_{op}	-40~+85	°C
Storage Temperature	T_{stg}	-40 ~ +125	°C
Reverse Voltage	V_r	15	V
Forward Current	I_f	2.0	mA
Lead Soldering Temperature(10 sec.)	T_{is}	260	°C

Detailed specification

Specifications	Testing condition	WSPR-IGA-55			Unit
		Min	Type	Max	
Sensitive Area	----		55		μm
Responsibility	=1310nm	0.8	0.85	----	A/W
	=1550nm	0.85	0.90	----	
Response Spectrum	-----	1100	1310	1650	nm
Dark Current (Typical)	$V_r=5V$		0.3	2.0	nA
Capacitance	$V_r=5V$	----	0.7	1.0	PF
Rise / Fall time	$V_r=5V$	----	----	0.30	ns
Bandwidth	3dB	----	2.0	----	GHz
Saturation power(Typical)	$V_r=5V$	----	2	----	mW
Package		Receptacle Package			
Fiber Connector		FC/SC/ST			

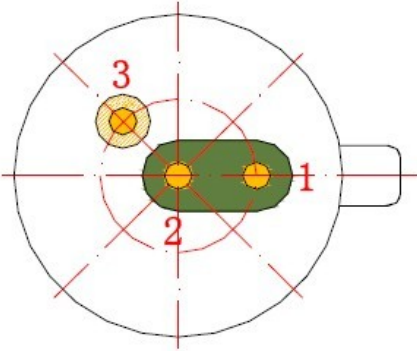

PIN View:
A:

1	PD(+)
2	PD(-)
3	GND

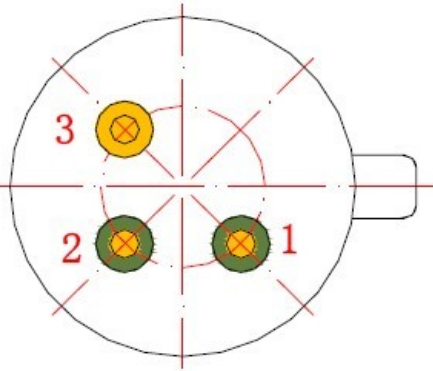
B:

1	PD(+)
2	PD(-)
3	GND

Package size
